

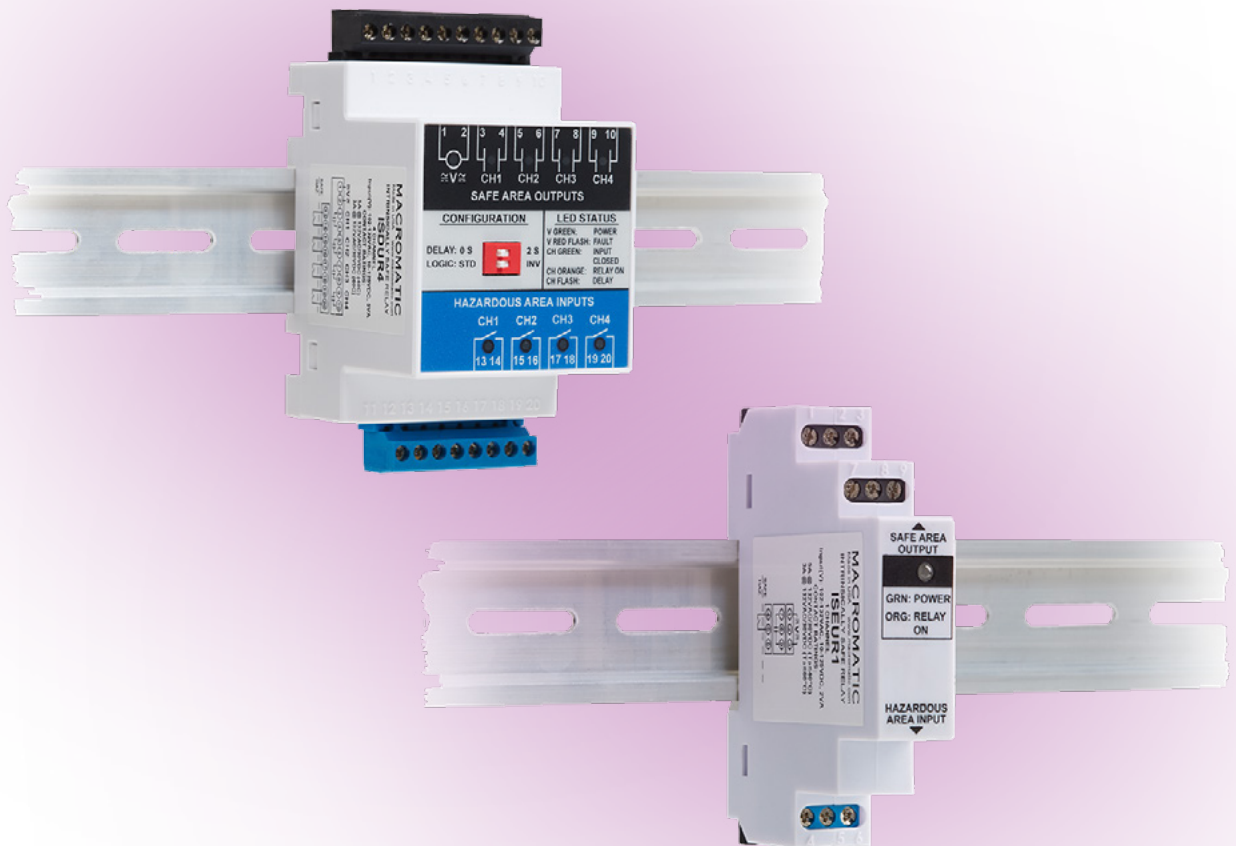

Better. By Design.

# INTRINSICALLY SAFE RELAYS

CATALOG OF PRODUCTS



# HAZARDOUS LOCATIONS OVERVIEW

When electrical equipment is used in, around, or near an atmosphere that has flammable gases or vapors, flammable liquids, combustible dusts, ignitable fibers or flyings, there is always a possibility or risk that a fire or explosion might occur. Those areas where the possibility or risk of fire or explosion might occur, due to an explosive atmosphere and/or mixture, are often called hazardous (or classified) locations. Currently, there are two systems used to classify these hazardous locations: the Class/Division system, used predominately in the United States, and the Zone system, generally used in the rest of the world.

## What's Needed for An Explosion?

The most common types of reaction are between flammable gases, vapors or dust with oxygen in the surrounding air. As a rule, three basic requirements must be met for an explosion to take place in atmospheric air:

1. Flammable substance
2. Oxygen
3. Source of Ignition (a spark or high heat)

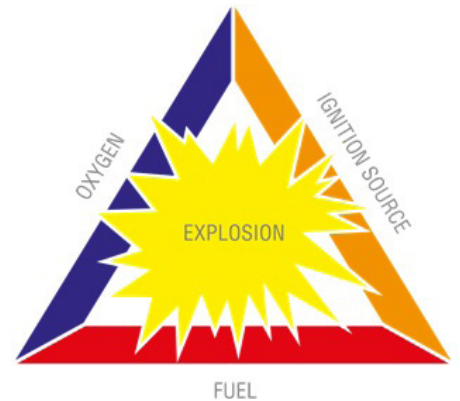

**Note:** both the flammable substance and the oxygen must be present in the correct mixture for the explosion to happen.

## How is the Explosion Controlled?

The objective of selecting electrical equipment and the means of installation is to reduce the hazard of the electrical equipment to an acceptable level. The most certain method of preventing an explosion is to locate electrical equipment outside of hazardous (classified) areas whenever possible. In situations where this is not practical, installation techniques and enclosures are available which meet the requirements for locating electrical equipment in such areas. These methods of reducing hazards are based on the elimination of one or more of the elements of the ignition triangle discussed earlier.

Three principles ensure that electrical equipment does not become a source of ignition:

1. **Contain the explosion:** measures must be taken to ensure the explosion cannot spread to the surrounding atmosphere (explosion-proof enclosures or conduit & cable seals)
2. **Isolate the hazard:** the surrounding atmosphere is prevented from entering the enclosure by maintaining a positive pressure of inert gas or clean air within the unit (pressurization and purging, oil immersion & hermetic sealing)
3. **Limit the energy:** potentially explosive mixtures can penetrate the enclosure but must not be ignited. Sparks and raised temperatures must only occur within certain limits (intrinsic safety)

All Macromatic IS Series Intrinsically Safe Relays follow the third principal: **limit the energy utilizing an intrinsically safe circuit.**

# HAZARDOUS LOCATION CLASSIFICATIONS

Standard classification systems provide a concise description of the hazardous material that may be present along with the probability of it being present so that the appropriate equipment may be used and safe installation practices followed. In North America, the classification system most widely used is defined by the NFPA Publication 70, NEC and CEC. They define the type of hazardous substances that is or may be present in the air in sufficient quantities to produce an explosion. The NFPA establishes area classifications based on Classes, Divisions and Groups which are factors combined to define the hazardous conditions of a specific area.

The table below summarizes the various hazardous (classified) locations:

Substance	Substance Class	Area Classification		Hazardous Location Characteristics
		NEC500	NEC505	
Gases/ Vapors	Class I (NEC 501)	Division 1	Zone 0	Explosion hazard present continuously or occasionally under normal operating conditions
			Zone 1	
		Division 2	Zone 2	Ignitable concentrations of flammable gases or vapors are not normally present, but could be present in the case of a fault
Dusts	Class II (NEC 502)	Division 1	Zone 20	Combustible dusts are present in quantities sufficient to produce explosive and ignitable
			Zone 21	
		Division 2	Zone 22	Combustible dust due to abnormal operations may be present in quantities sufficient to produce explosive or ignitable mixtures
Fibers	Class III (NEC 503)	Division 1	Not equivalent	Easily ignitable fibers/flyings are handled or manufactured
		Division 2		Easily ignitable fibers/flyings are stored or handled

The Macromatic ISD & ISE Series of Intrinsically Safe Relays are certified Class I, Division 1 in the United States and Class I, Zones 0 and 1 in Canada.

The Macromatic ISD & ISE Series of Intrinsically Safe Relays have been tested and approved for listing under Underwriters Laboratory (UL) 913 Intrinsically Safe Apparatus and Associated Apparatus 8th Edition. The Macromatic ISP Series of Intrinsically Safe Relays have been tested and approved for listing under Underwriters Laboratory (UL) 913 Intrinsically Safe Apparatus and Associated Apparatus 6th Edition. The input or inputs to these devices have been approved for use in all Classes, Groups and Divisions.

# 4-CHANNEL INTRINSICALLY SAFE RELAYS

## ISD SERIES



- ◆ Approved for use in Class I, Class II, and Class III Hazardous Locations (Zones 0 & 1 in Canada)
- ◆ 4-Channel
- ◆ Isolated input terminals
- ◆ Isolated 5A relay outputs
- ◆ Pluggable terminals offer easy installation & replacement
- ◆ Universal input voltage of 102-132V AC & 10-125V DC
- ◆ Compact 60mm wide enclosure for both DIN-rail or panel-mount
- ◆ Standard & inverse logic
- ◆ Instantaneous & delayed response times
- ◆ LED status indicator



Better. By Design.

**800.238.7474**  
**WWW.MACROMATIC.COM**  
**SALES@MACROMATIC.COM**

The ISD Series of Intrinsic Safe Relays provide a safe and reliable method to control up to four loads (motor starters, relays, etc.) with up to four input devices (switches, sensors, etc.) located in a hazardous area. These products are approved for use in Class I Groups A, B, C, D, Class II Groups E, F, G, and Class III Hazardous Locations (Zones 0 & 1 in Canada). The ISD Series relay must be mounted in a safe area, following Macromatic Control Drawing Number ISD1A04, as shown in Instruction Sheet 901-0000-328.

The ISD Series relays utilize a compact 60mm wide enclosure that can be both mounted on 35mm DIN rail or panel-mounted with two screws. Terminals for the input devices from the hazardous area are on the bottom of the unit for easy access in the enclosure to incoming wiring from the hazardous area. Pluggable terminal blocks on both the input and output sides allow for easy initial wiring of the unit as well as replacement without having to remove any wires. Each input has two terminals, which eliminates the need to mount a separate terminal block to connect multiple incoming COM wires. Each output relay has two terminals for isolation from the others, allowing outputs to be at different voltages, i.e., contactor coils at 120V AC and an alarm circuit at 24V DC. A universal input voltage of 102-132V AC & 10-125V DC covers a variety of applications with one device.

### Operation

Each ISD Series product consists of 4 intrinsically safe inputs and 4 corresponding electromechanical relay outputs. With input voltage applied, the V LED will be ON (GREEN) to indicate power is applied. When the input device is closed, the input LED is ON (GREEN). When the output relay is energized, the output LED is ON (ORANGE).

These products offer four operating configurations to meet a wide variety of applications. Each configuration is user-selectable using two DIP-switches easily accessible and clearly marked on the top of the product. Each setting will apply to all channels:



### Standard Logic (DIP Switch set to "STD"):

When the input device in the hazardous area is closed, the corresponding output relay is energized. When the input device opens, the corresponding output relay will de-energize.

### Inverse Logic (DIP Switch set to "INV"):

When the input device in the hazardous area is open, the corresponding output relay is energized. When the input device closes, the corresponding output relay will de-energize.

### No Time Delay (DIP Switch set to "0 S"):

The output relay will have an immediate change in status in response to the input device closing or opening.

### Fixed 2 Second Delay (DIP Switch set to "2 S"):

The output relay will delay 2 seconds before a change of status in response to the input device closing or opening.

INPUT VOLTAGE	NUMBER OF CHANNELS	CATALOG NUMBER	WIRING
102-132V AC (50/60Hz) & 10-125V DC	4	ISDUR4	<p><b>DIAGRAM 814</b></p>

# 4-CHANNEL INTRINSICALLY SAFE RELAYS

## ISD SERIES

### APPLICATION DATA

**Input Voltage:** 102-132V AC (50/60Hz.) & 10-125V DC

**Load (Burden):** 5VA Maximum

**Input Switch Open Circuit Voltage:** 10V DC

**Output Contacts:**

SPST-NO (Form A) 3A Resistive @ 125V AC @60°C & 30V DC Resistive, Pilot Duty Rating D300

SPST-NO (Form A) 5A Resistive @ 125V AC @40°C & 30V DC Resistive, Pilot Duty Rating D300

**Life:** Electrical: 50,000 Closures @ Full Load AC  
Mechanical: 5 Million Closures @ No Load

**Response Times:**

Standard (DIP Switch set to "0S"): < 50ms  
Delay (DIP Switch set to "2S"): Fixed 2 Seconds

**Temperature:**

Operating: -28° to + 60° C (-18° F to +140° F)  
Storage: -55° to +85° C (-67° to 185° F)

**LED Indication:**

V: ON (Green); Inputs: ON (Green); Outputs: ON (Orange)

**Insulation Voltage:**

1500 V AC between coil & contacts  
750 V AC between open contacts  
1500 V AC between contacts of different output channels  
1500 V AC between hazardous and safe circuits

**Wire Sizes:**

One #14-24 AWG Conductor or  
Two #16 or 18 AWG Conductors

**Mounting:** Mounts on 35mm DIN-rail or panel-mounted with two #8 screws when DIN-rail clips are fully extended from under the enclosure.

**Control Drawing:** See Instruction Sheet 901-0000-328, which includes Control Drawing ISD1A04.

**Approvals:**



UL913 8th Edition  
E318075



### DIMENSIONS

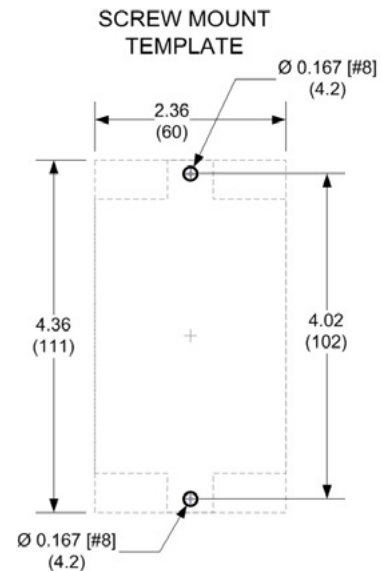
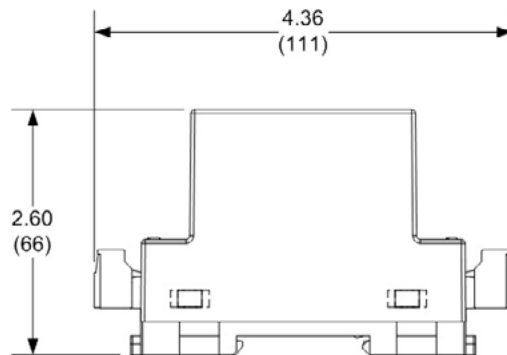
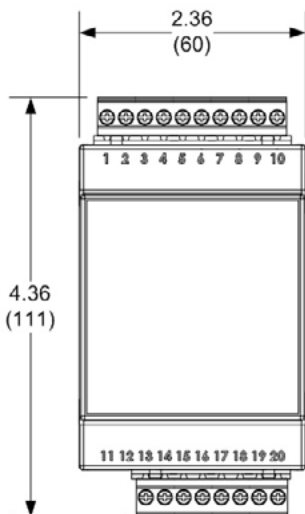

All Dimensions in Inches (Millimeters)

# 1-CHANNEL INTRINSICALLY SAFE RELAYS

## ISE SERIES



- ◆ Approved for use in Class I, Class II, and Class III Hazardous Locations (Zones 0 & 1 in Canada)
- ◆ 1-Channel
- ◆ 5A relay output
- ◆ Universal input voltage of 102-132V AC & 10-125V DC
- ◆ Compact 17.5mm wide enclosure for both DIN-rail or panel-mount
- ◆ LED status indicator



Better. By Design.

**800.238.7474**  
**WWW.MACROMATIC.COM**  
**SALES@MACROMATIC.COM**

The ISE Series of Intrinsic Safe Relays provide a safe and reliable method to control a single load (motor starters, relays, etc.) with a single input device (switches, sensors, etc.) located in a hazardous area. These products are approved for use in Class I Groups A, B, C, D, Class II Groups E, F, G, and Class III Hazardous Locations (Zones 0 & 1 in Canada). The ISE Series relay must be mounted in a safe area, following Macromatic Control Drawing Number ISD2A01, as shown in Instruction Sheet 901-0000-329.

The ISE Series relays utilize a compact 17.5mm wide enclosure that can be both mounted on 35mm DIN rail or panel-mounted with two screws. Hazardous terminals are on the bottom of the unit for easy access in the enclosure to incoming wiring from the hazardous area and are clearly marked.

### Standard Operation

Each ISE Series relay consists of an intrinsically safe input and a corresponding electromechanical relay output. There is one bi-color LED for status indication. With input voltage applied, the LED will be ON (Green) to indicate power is applied.

When the input device from the hazardous area is *closed*, the output relay is energized and the LED is ON (Orange). When the input device *opens*, the output relay will de-energize and the LED will be ON (Green).

### Inverted Operation (V-suffix)

Each ISE Series relay consists of an intrinsically safe input and a corresponding electromechanical relay output. There is one bi-color LED for status indication. With input voltage applied, the LED will be ON (GREEN) to indicate power is applied.

When the input device from the hazardous area is *open*, the output relay is energized and the LED is ON (ORANGE). When the input device *closes*, the output relay will be de-energized and the LED will be ON (GREEN).

INPUT VOLTAGE	NUMBER OF CHANNELS	CATALOG NUMBER	WIRING
102-132V AC (50/60Hz) & 10-125V DC	1	ISEUR1	<p>DIAGRAM 811</p>
102-132V AC (50/60Hz) & 10-125V DC	1	ISEUR1V	<p>DIAGRAM 811</p>

# 1-CHANNEL INTRINSICALLY SAFE RELAYS

## ISE SERIES

### APPLICATION DATA

**Input Voltage:** 102-132V AC (50/60Hz.) & 10-125V DC

**Load (Burden):** 2VA Maximum

**Input Switch Open Circuit Voltage:** 10V DC

**Output Contacts:**

SPST-NO (Form A) 3A Resistive @ 125V AC @ 60°C & 30V DC Resistive, Pilot Duty Rating D300

SPST-NO (Form A) 5A Resistive @ 125V AC @ 40°C & 30V DC Resistive, Pilot Duty Rating D300

**Life:** Electrical: 50,000 Closures @ Full Load AC  
Mechanical: 5 Million Closures @ No Load

**Response Times:** < 50ms

**Temperature:**

Operating: -28° to + 60° C (-18° F to +140° F)  
Storage: -55° to +85° C (-67° to 185° F)

**LED Indication:**

Standard Operation, ON (Green) - Input voltage; ON (Orange) - Input closed and relay energized;  
Inverse Operation (V-suffix), ON (Green) - Input voltage; ON (Orange) - Input open and relay energized

**Insulation Voltage:**

1500 V AC between coil & contacts  
750 V AC between open contacts  
1500 V AC between hazardous and safe circuits

**Wire Sizes:**

One #14-24 AWG Conductor or  
Two #16 or 18 AWG Conductors

**Mounting:** Mounts on 35mm DIN-rail or panel-mounted with two #8 screws when DIN-rail clips are fully extended from under the enclosure.

**Control Drawing:** See Instruction Sheet 901-0000-329, which includes Control Drawing ISD1A04.

**Approvals:**



UL913 8th Edition  
E318075



### DIMENSIONS

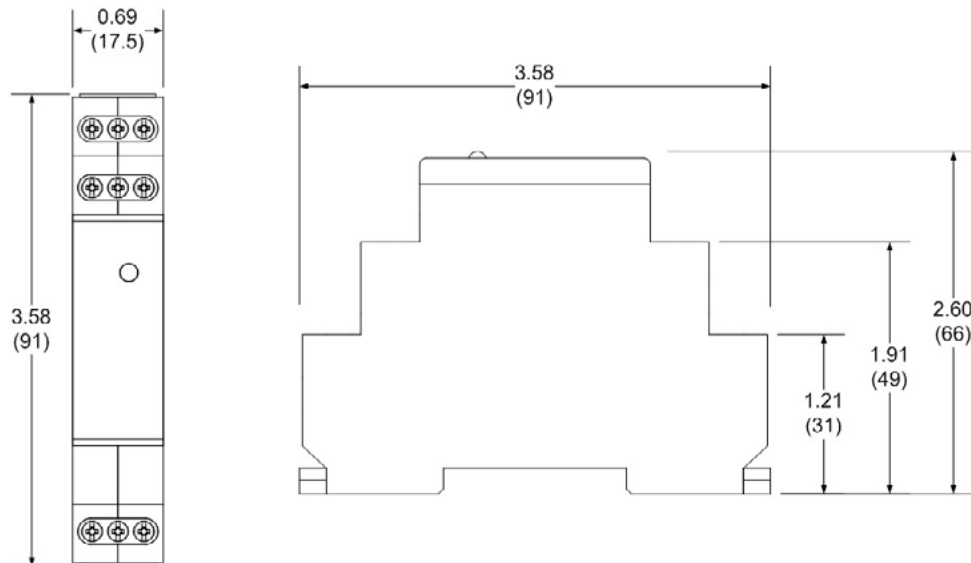

All Dimensions in Inches (Millimeters)

# 1-CHANNEL INTRINSICALLY SAFE RELAYS

## ISP SERIES



- ◆ Approved for use in Class I, Class II, and Class III Hazardous Locations
- ◆ 1-Channel
- ◆ Input voltage of 120V AC
- ◆ 10A relay output
- ◆ Plug-in enclosure
- ◆ LED status indicator



The ISP Series of Intrinsic Safe Relays provide a safe and reliable method to control a single load (motor starters, relays, etc.) with a single input device (switches, sensors, etc.) located in a hazardous area. These products are approved for use in Class I Groups A, B, C, D, Class II Groups E, F, G, and Class III Hazardous Locations. The ISP Series relay must be mounted in a non-hazardous area, following Macromatic Control Drawing Number ISR2A01D as shown in Instruction Sheet 901-0000-260.

The ISP Series relays utilize an 8 pin plug-in enclosure (included) that can be both mounted on 35mm DIN rail or panel-mounted with two screws.

### Operation

Each ISP Series relay consists of an intrinsically safe input and a corresponding electromechanical relay output. There is one LED for status indication. With input voltage applied, the LED will be OFF. When the input device from the hazardous area is closed, the output relay is energized and the LED is ON (Green). When the input device opens, the output relay will de-energize and the LED will be OFF.

INPUT VOLTAGE 50/60Hz	NUMBER OF CHANNELS	CATALOG NUMBER	WIRING/SOCKETS ■
120V AC	Single	ISP120A	<p><b>DIAGRAM 160</b></p>

- Both an integral spring mating clip and the appropriate 8 pin socket are included with the plug-in relay.



Better. By Design.

**800.238.7474**

**WWW.MACROMATIC.COM**

**SALES@MACROMATIC.COM**

Sockets & Accessories available



# SINGLE CHANNEL INTRINSICALLY SAFE RELAYS

## ISP SERIES

### APPLICATION DATA

**Input Voltage:**

120V AC,  $\pm 10\%$ , 50/60Hz

**Load (Burden):**

1.25 VA

**Output Contacts:**

SPST-NO 10A @ 120V AC Resistive

**Life:**

Mechanical: 10,000,000 operations

Full Load: 100,000 operations

**Response Times:**

Operate: 11 ms

Release: 4 ms

**Temperature:**

Operate:  $-20^{\circ}$  to  $60^{\circ}\text{C}$  ( $-4^{\circ}$  to  $140^{\circ}\text{F}$ )

Storage:  $-45^{\circ}$  to  $85^{\circ}\text{C}$  ( $-49^{\circ}$  to  $185^{\circ}\text{F}$ )

**Insulation Voltage:**

2,000 volts

**LED Indicator:**

Green ON when relay is energized & OFF when relay is de-energized.

**Mounting:**

Both an integral spring mating clip and the appropriate 8 pin socket are included with the plug-in relay. The socket can be both mounted on 35mm DIN rail or panel-mounted with two screws.

**Control Drawing:** See Instruction Sheet 901-0000-260, which includes Control Drawing ISR2A01D.

**Approvals:**

File #E318075

### DIMENSIONS

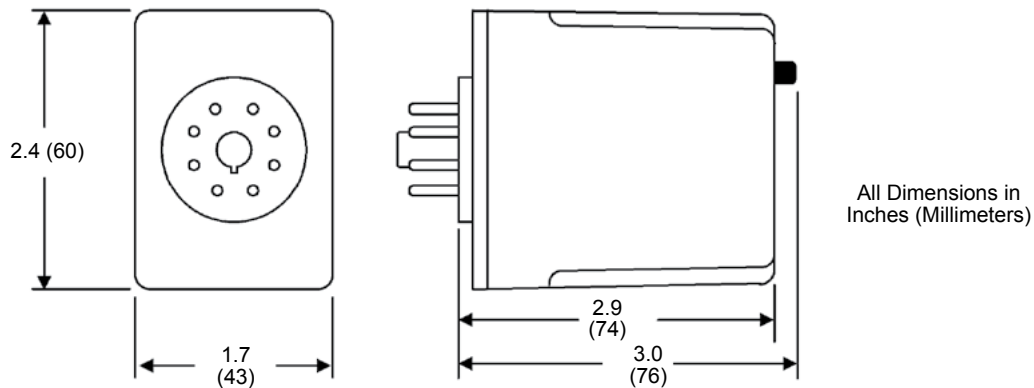



# MACROMATIC INDUSTRIAL CONTROLS

Located in Menomonee Falls, Wisconsin, Macromatic Industrial Controls engineers and manufactures industrial relays that control electrical processes and monitor power for damaging fault conditions.

Macromatic provides solutions for almost any application in any industry. Macromatic's products are used in the HVACR, pump control, material handling, motor control, generator, and lift and elevator industries, plus more.

As an independently-owned manufacturer of state-of-the-art control and monitoring products for over 40 years, Macromatic takes pride in its short lead-time, flexible product design, and exceptional technical support.

Visit [www.macromatic.com](http://www.macromatic.com) today.



Better. By Design.

800.238.7474 | [WWW.MACROMATIC.COM](http://WWW.MACROMATIC.COM) | [SALES@MACROMATIC.COM](mailto:SALES@MACROMATIC.COM)

# MACROMATIC INDUSTRIAL CONTROLS

## FAMILY OF PRODUCTS

MACROMATIC INDUSTRIAL CONTROLS

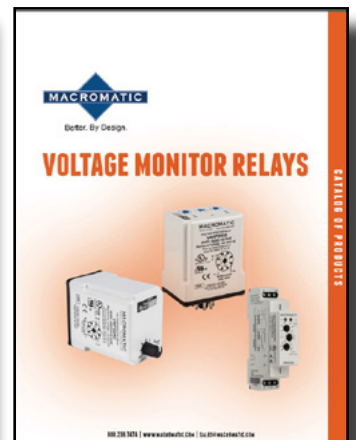
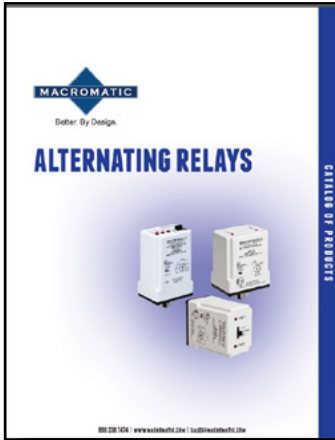

Better. By Design.

800.238.7474 | [WWW.MACROMATIC.COM](http://WWW.MACROMATIC.COM) | [SALES@MACROMATIC.COM](mailto:SALES@MACROMATIC.COM)

3.14.19

Specifications subject to change without notice | Macromatic is a registered trademark of Macromatic Industrial Controls, Inc.